

Appliance schedule

30" Gaggenau - oven, left hinged, BO 481611
 36" Gaggenau - gas cooktop, VG 491210CA
 36" Gaggenau - visor hood, AF210791
 24" Liebherr - refrigerator, fully integrated, HRB 1120
 24" Liebherr - fridge /freezer, fully integrated, HC 1080
 24" Miele - dishwasher, fully integrated, G 4971 SCVi AM

Faucet - 'by client/GC'
 Sink - 'by client/GC'
 Waste bins - 'by bulthaup'
 LED strips Loox Haefele 'provided by bulthaup'

- finishes:**
- base units 1ML1 - mat lacquer q8 - alpine white
 - tall units 1ML1 - mat lacquer q8 - alpine white
 - island base units 1ML1 - mat lacquer q8 - alpine white
 - wall units 1ML1 - mat lacquer q8 - alpine white
 - wall panel Elevation A CNXX - stainless steel
 - worktop E Elevation A CNXX - stainless steel
 - worktop island by others
 - recess channel A1AX - aluminum

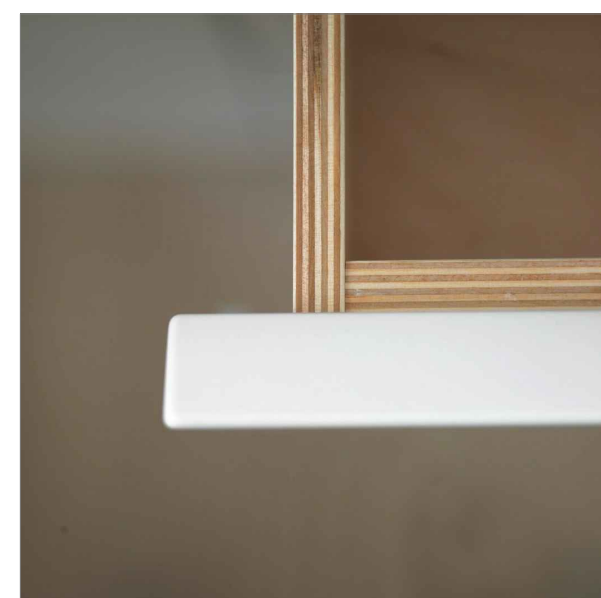
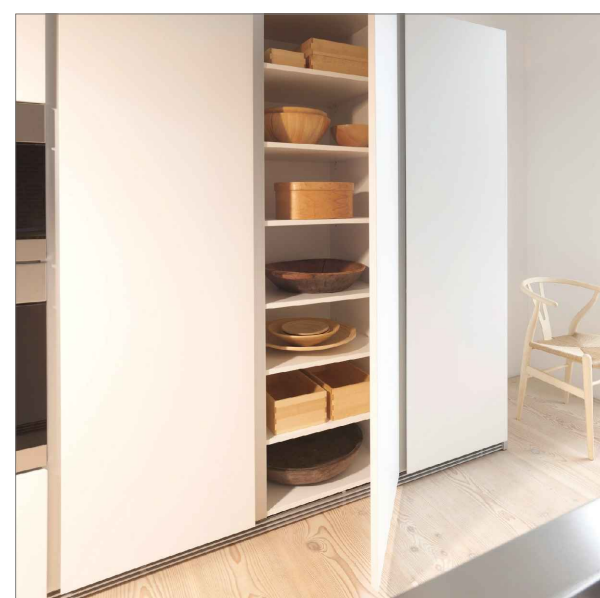
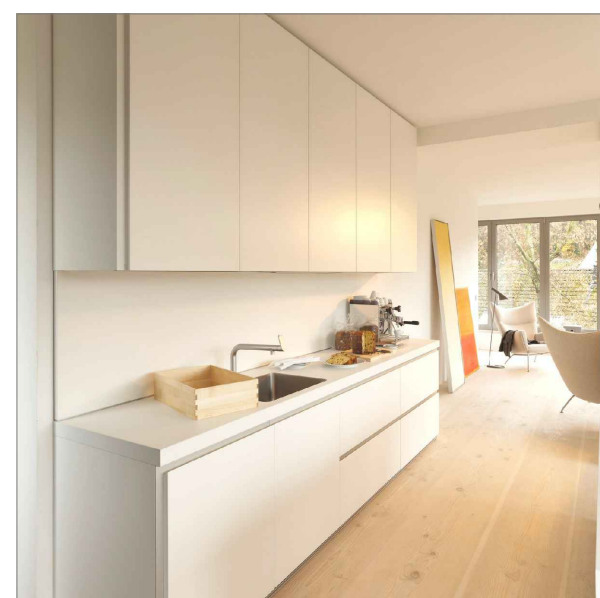
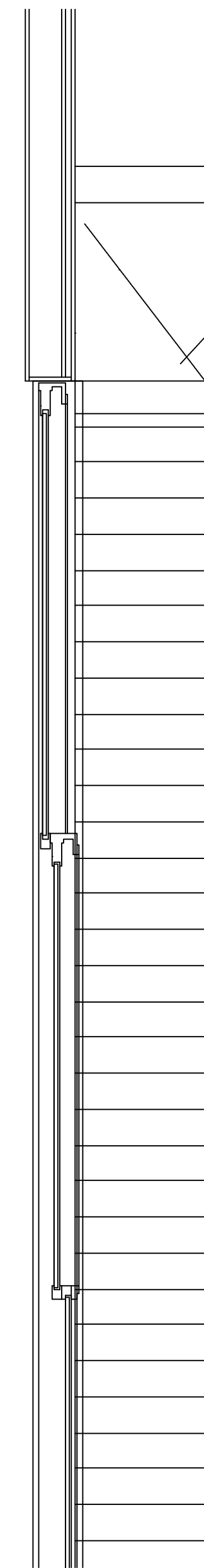

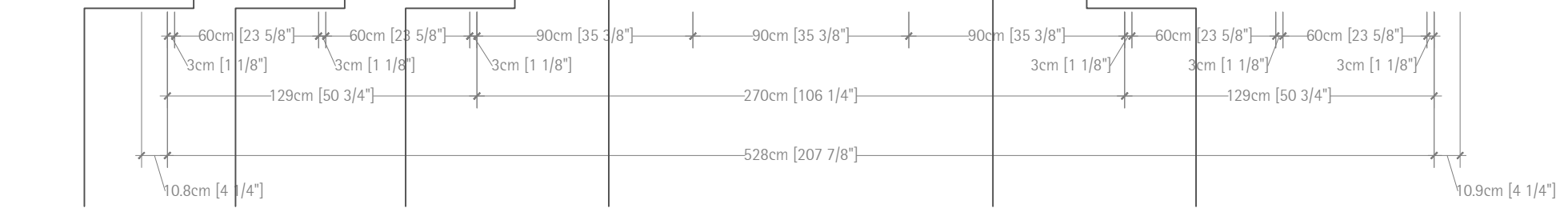
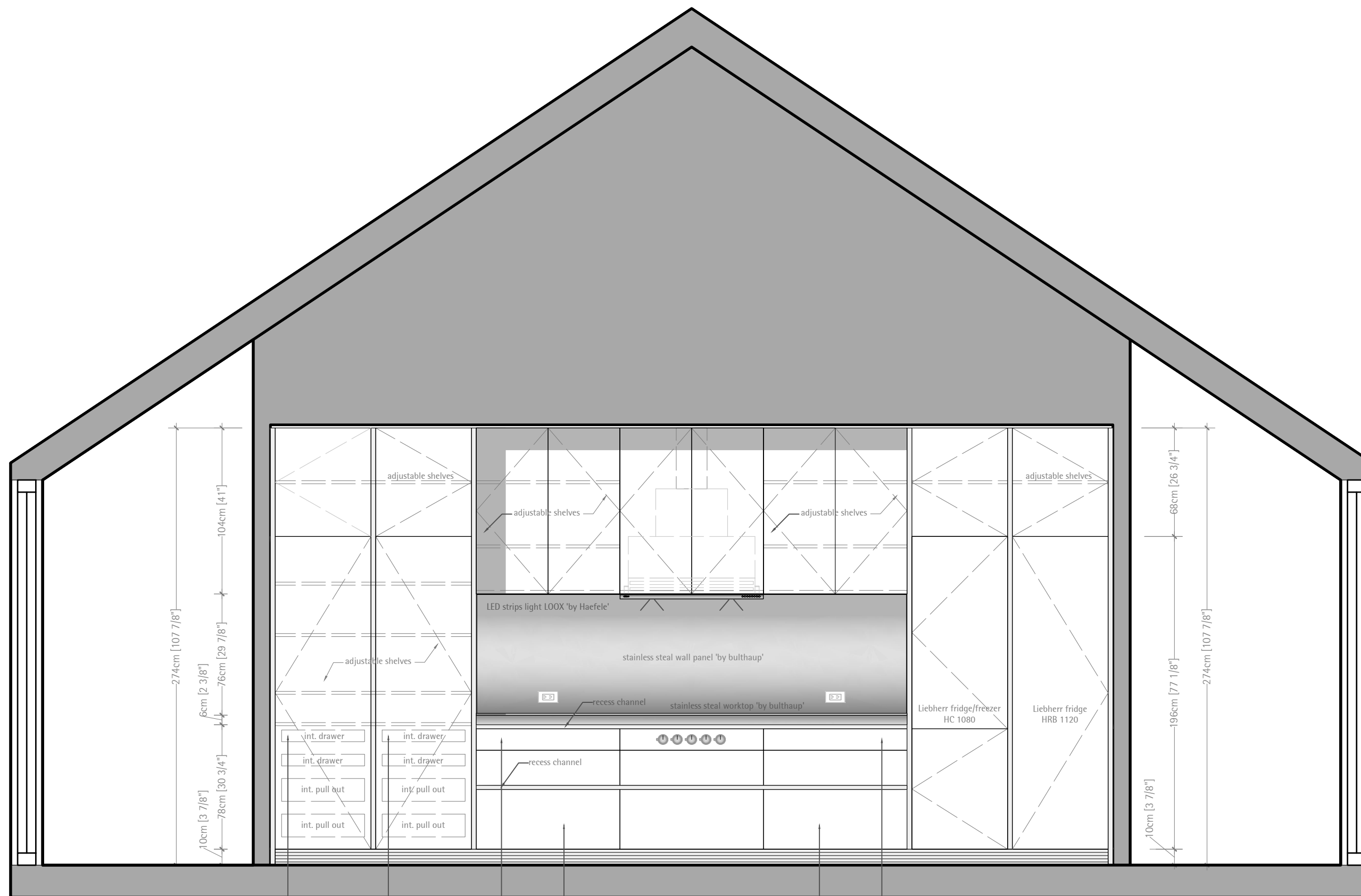

Elevation A

- birch drawer inserts
1x utensils insert 11UE2246
1x cutlery insert 11BE2046
- birch drawer inserts
1x utensils insert 11UE2246
1x cutlery insert 11BE2046
- birch drawer inserts
1x utensils insert 11UE3046
1x cutlery insert 11BE3046
1x knife insert 11ME2246
- birch pull container
2x 11HC2246
- birch pull container
2x 11HC2246
- birch drawer inserts
1x utensils insert 11UE3046
1x cutlery insert 11BE3046
1x knife insert 11ME2246



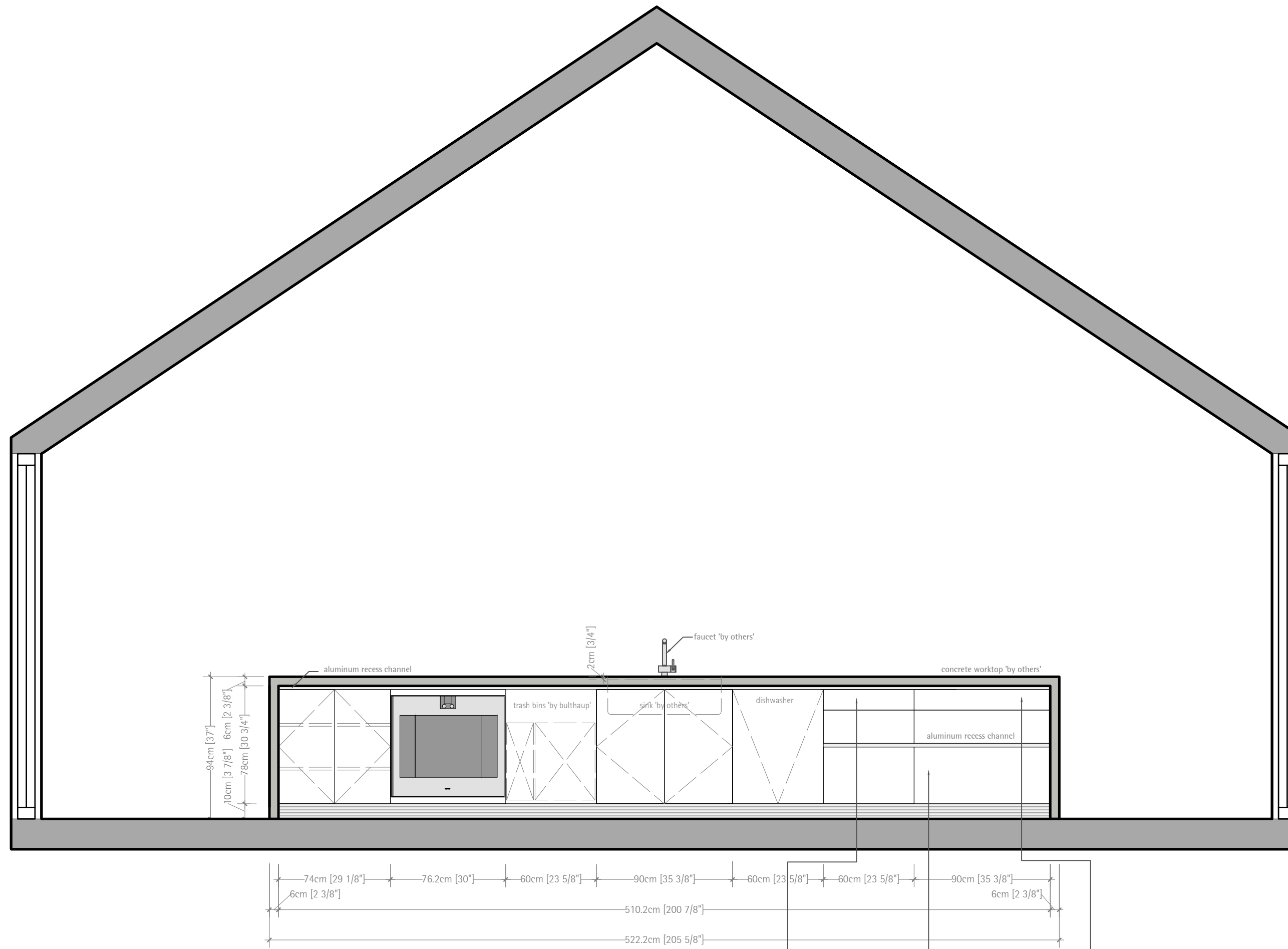

Elevation B - OPTION 1

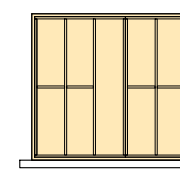

birch drawer inserts
1x cutlery insert 118E3046
1x cutlery insert 118E2246

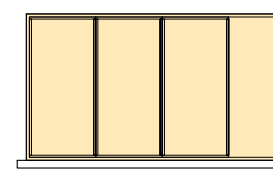

birch pull container
3x 11HC2246

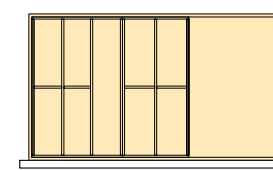

birch drawer inserts
1x cutlery insert 118E3046
1x cutlery insert 118E2246

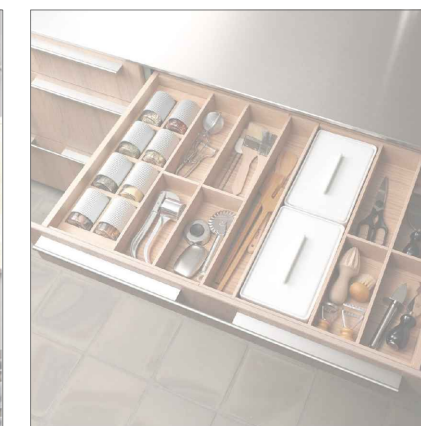

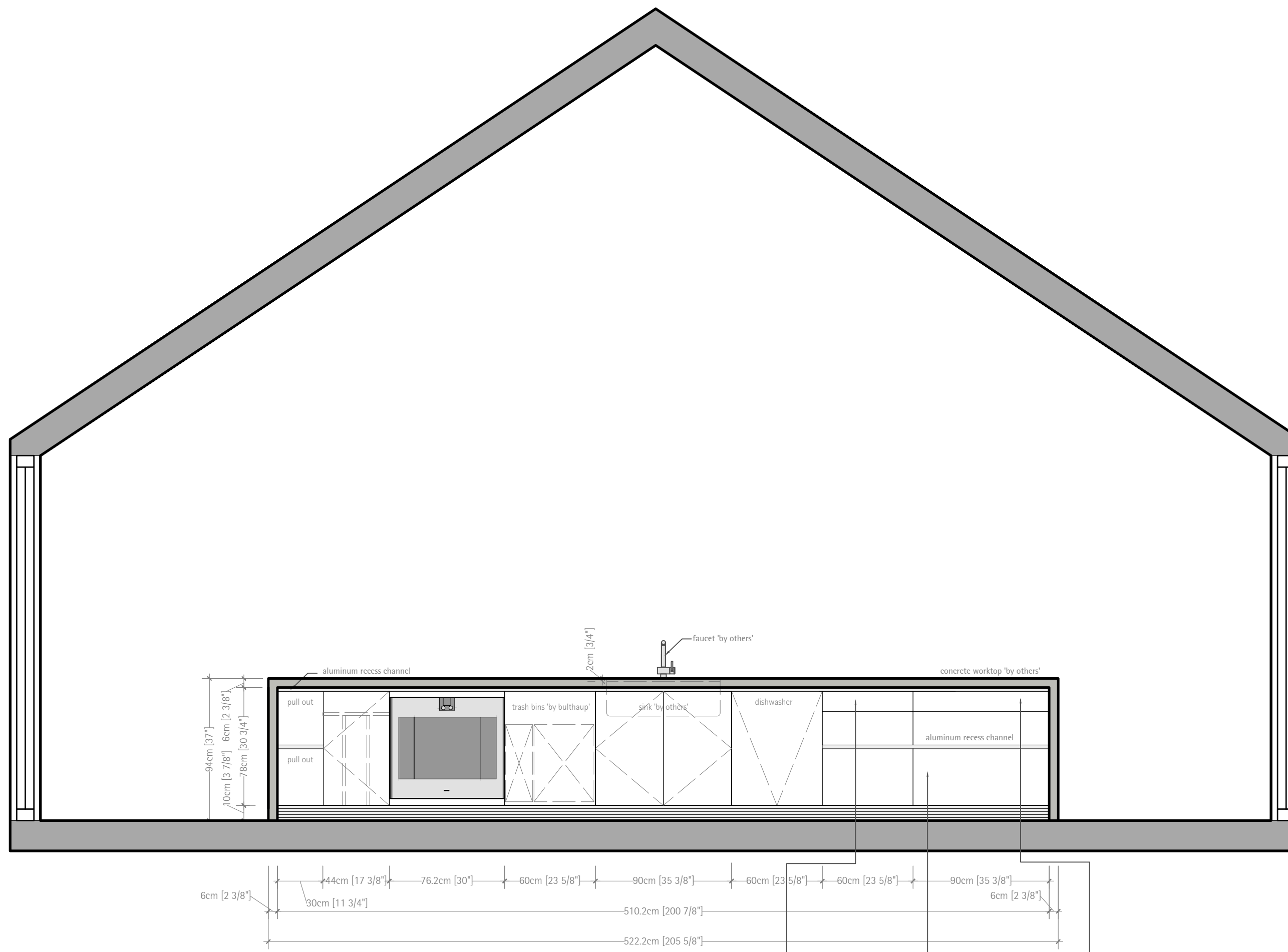

Elevation B - OPTION 2

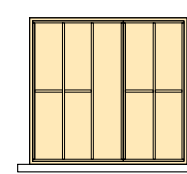

birch drawer inserts
 1x cutlery insert 11BE3046
 1x cutlery insert 11BE2246

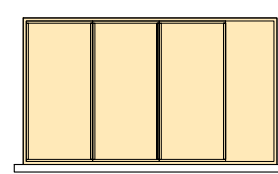

birch pull container
 3x 11HC2246

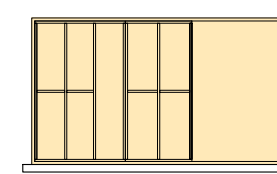

birch drawer inserts
 1x cutlery insert 11BE3046
 1x cutlery insert 11BE2246

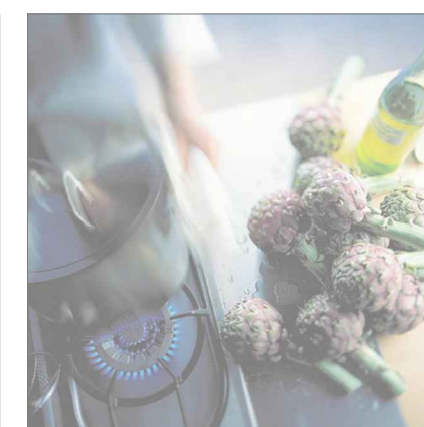
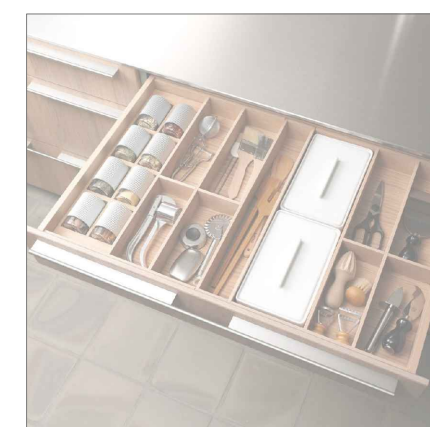

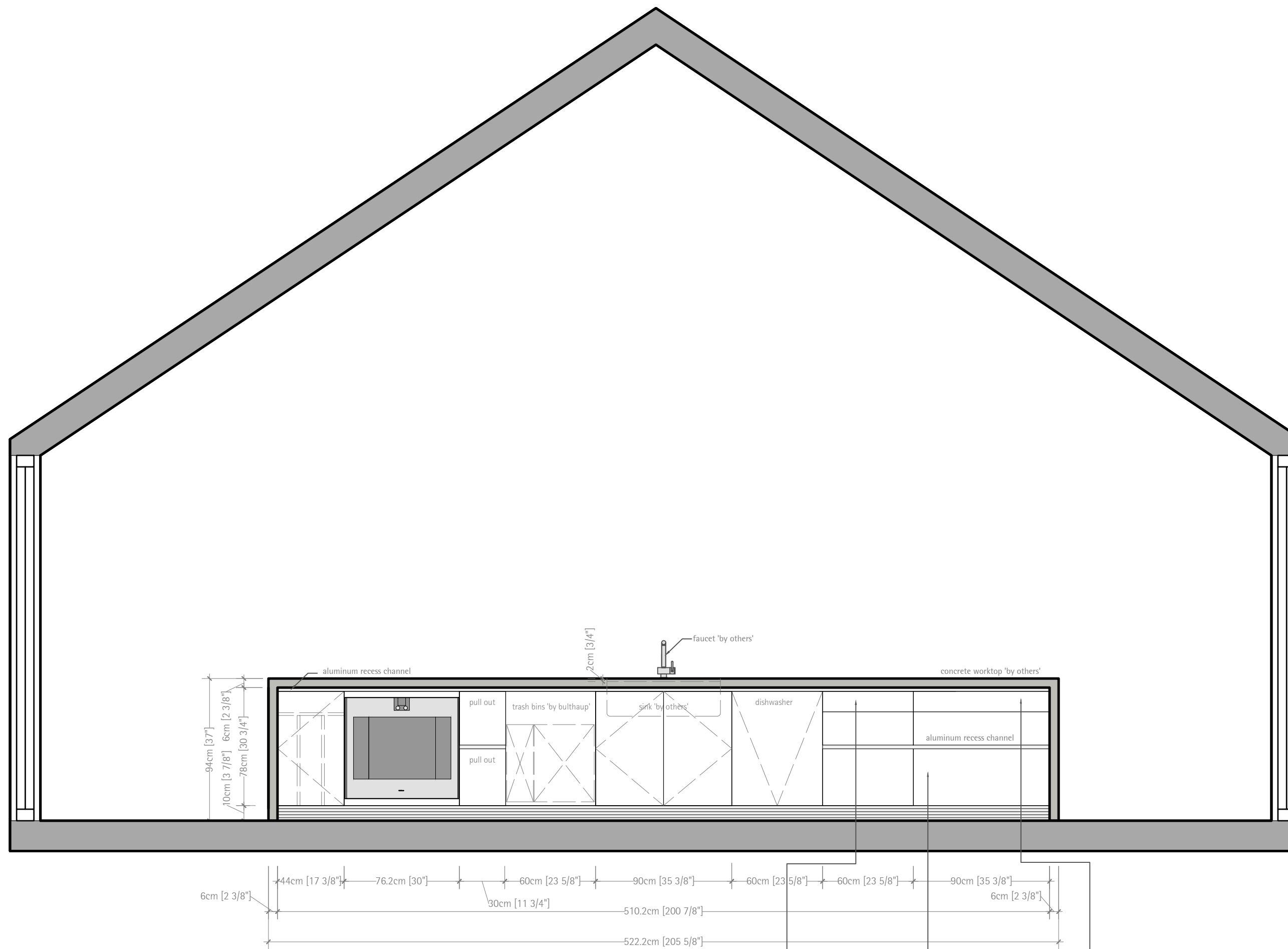

Elevation B - OPTION 3

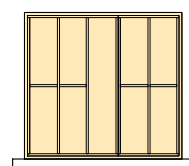

birch drawer inserts
1x cutlery insert 11BE3046
1x cutlery insert 11BE2246

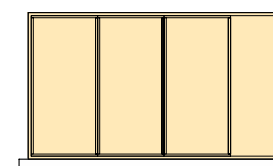

birch pull container
3x 11HC2246

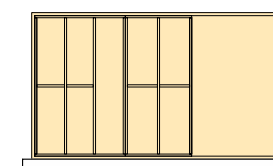

birch drawer inserts
1x cutlery insert 11BE3046
1x cutlery insert 11BE2246

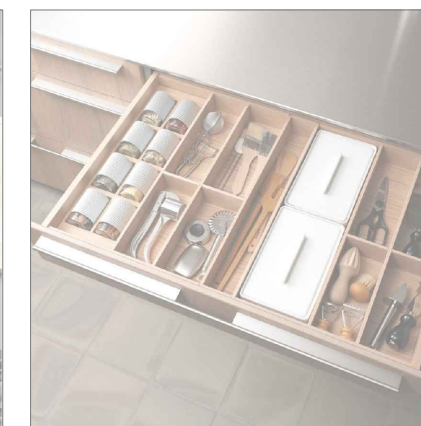

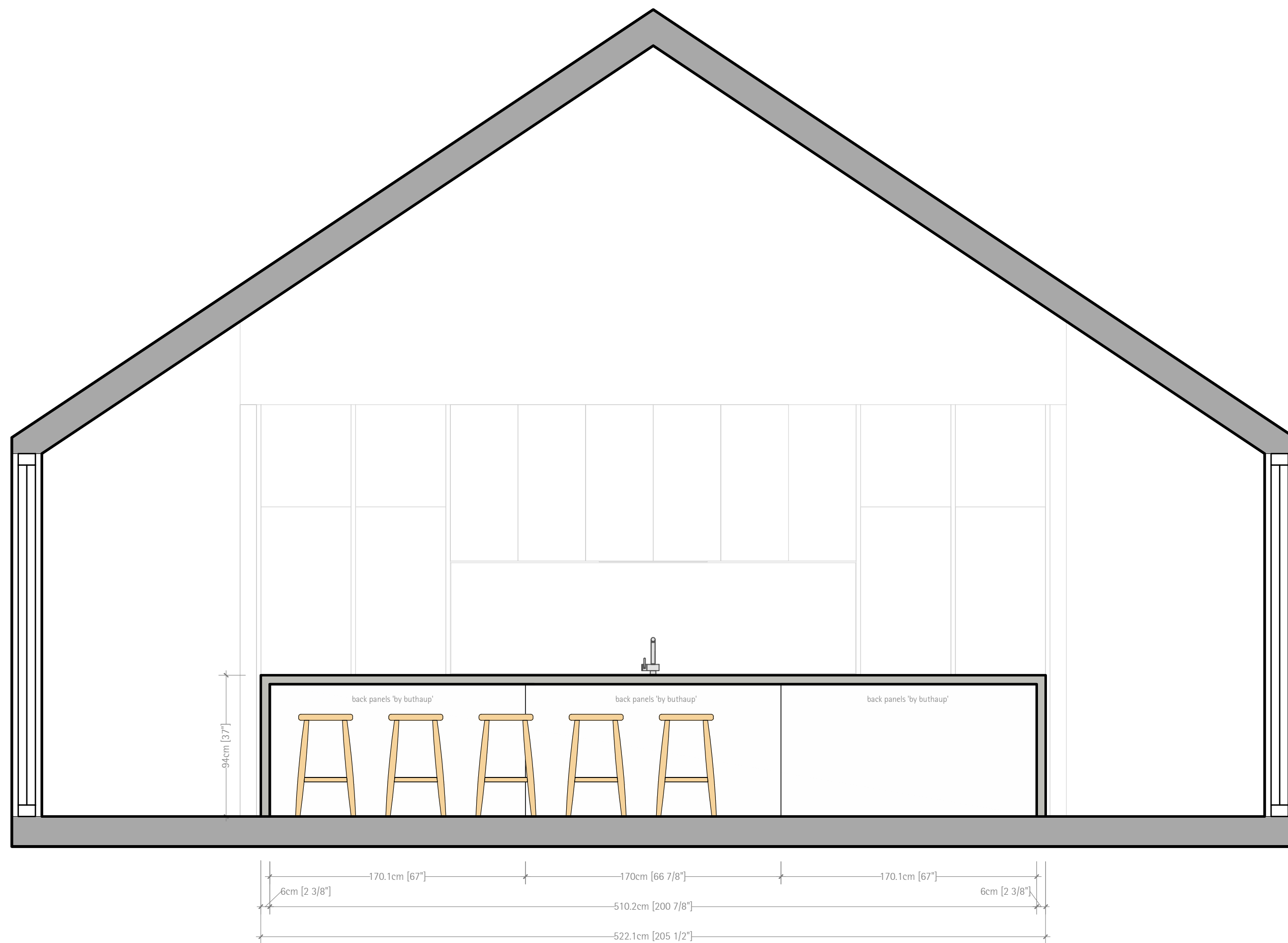

Elevation C



proj. coord. Nicolette Petrouleas
 content Elevation C
 date July 26, 2017
 sheet 5 of 6

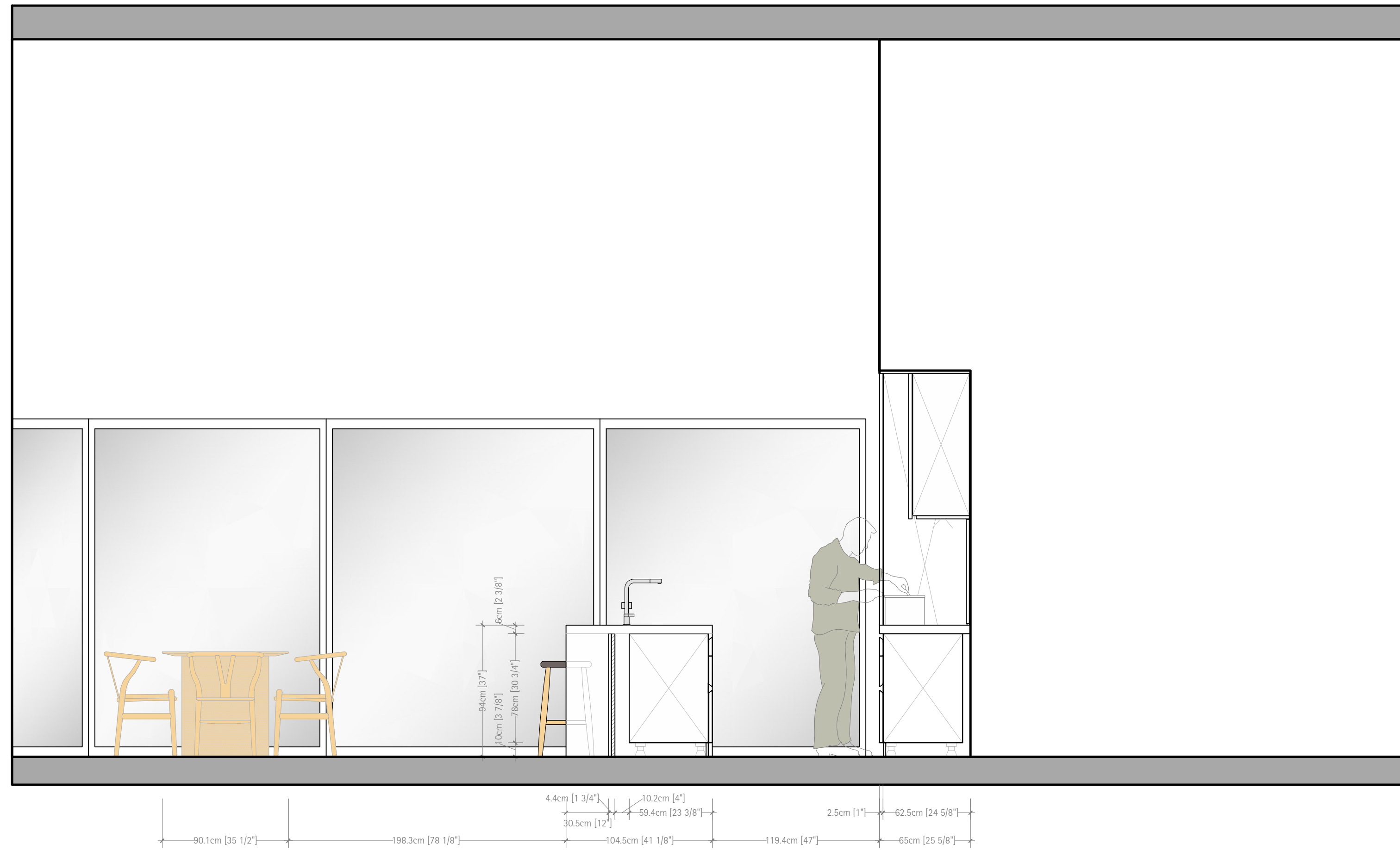

Elevation D

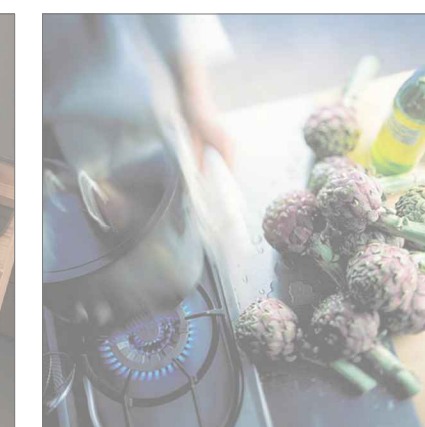
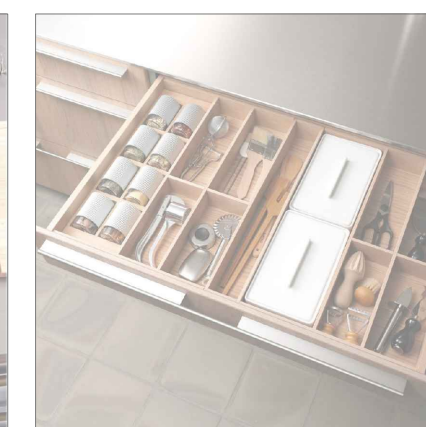

proj. coord. Nicolette Petrouleas
 content Elevation D
 date July 26, 2017
 sheet 6 of 6

SUGGESTED MECHANICAL ONLY

NOTE: ALL CONNECTIONS MUST BE DONE IN ACCORDANCE TO LOCAL CODES
All appliances installed according to specifications

APPLIANCE SCHEDULE & REQUIREMENTS @ Feder Residence

- 36" Gas Cooktop, GAGGENAU - VG 491 210CA (120V, 60Hz, 2Amps, GAS) connecting cable 55" with plug.
- 36" Visor Hood, GAGGENAU - AF210761 recirculation (120v, 60Hz, 10Amps, duct size 5 7/8"/150mm)
- 24" Fridge / Freezer, LIEBHERR - HC 1080 with ice maker (150v, 60Hz, WATER)
- 24" Refrigerator LIEBHERR - HC 1120 (150v, 60Hz)
- 30" Single Oven, GAGGENAU - BO 481 611, left hinge (208/220-240V, 60Hz, 25amps) plan for a 5' connecting cable (hardwire required)
- 24" Dishwasher, MIELE - G 4971 SCVi AM, Fully integrated (110V/120V, 60Hz, 15Amps, 4.35-145psi, WATER/DRAIN) power length NEMA 5-15 plug, 5'6" convertible hardwire.

SINK - 75cm provided 'by client/architect'
FAUCET - provided 'by client/architect'
LIGHTS - Hafele LOOX / LED strip provided 'by bulthaup'

PLEASE NOTE: BULTHAUP CABINETS ARE FABRICATED PER ABOVE LISTED APPLIANCES. ANY MODIFICATIONS TO THIS APPLIANCE LIST MAY RESULT IN DELAY OF PRODUCTION SCHEDULE AND/OR INCUR ADDITIONAL FURNITURE AND INSTALLATION COST.

ALL SITE DIMENSIONS TO BE FIELD VERIFIED AND COORDINATED BETWEEN A BULTHAUP REP. AND GENERAL CONTRACTOR.

CONVENIENCE OUTLET LOCATIONS
All convenience outlets located are a suggested guide only. Client/Architect to confirm all locations. Outlets to be installed in accordance with local code.

UNDER-CABINET/ SHELF LIGHTS
GC/Electrician to provide ON/OFF light switch.
GC/Electrician to review/confirm with client/architect light switch option. -Independent/dedicated on/off switch or on/off switch as part of master lighting control type

Mechanical Symbols

- Gas Line
- Water Line
- Electrical Outlet 120 V
- Electrical Outlet 240 V
- Central Line
- Drain

ALL CONNECTIONS MUST BE DONE IN ACCORDANCE TO LOCAL BUILDING CODES.

NOTE TO CONTRACTOR:

- SET ALL ELECTRICAL BOXES, WATER BOXES, & GAS VALVE FLUSH TO PLYWOOD/DRYWALL.
- NO EXTRUDED BOXES; EXTRUDED BOXES MAY INTERFERE WITH CABINETS & APPLIANCES FITTINGS.
- Electrician to provide all receptacles/cover plates and make final connections
- Plumber to provide all plumbing fitting elements and make all final connections.

* bulthaup installers are not qualified electricians and/or plumber.

*GC/HVAC to provide and make all ducting connections bulthaup installers are not qualified HVAC

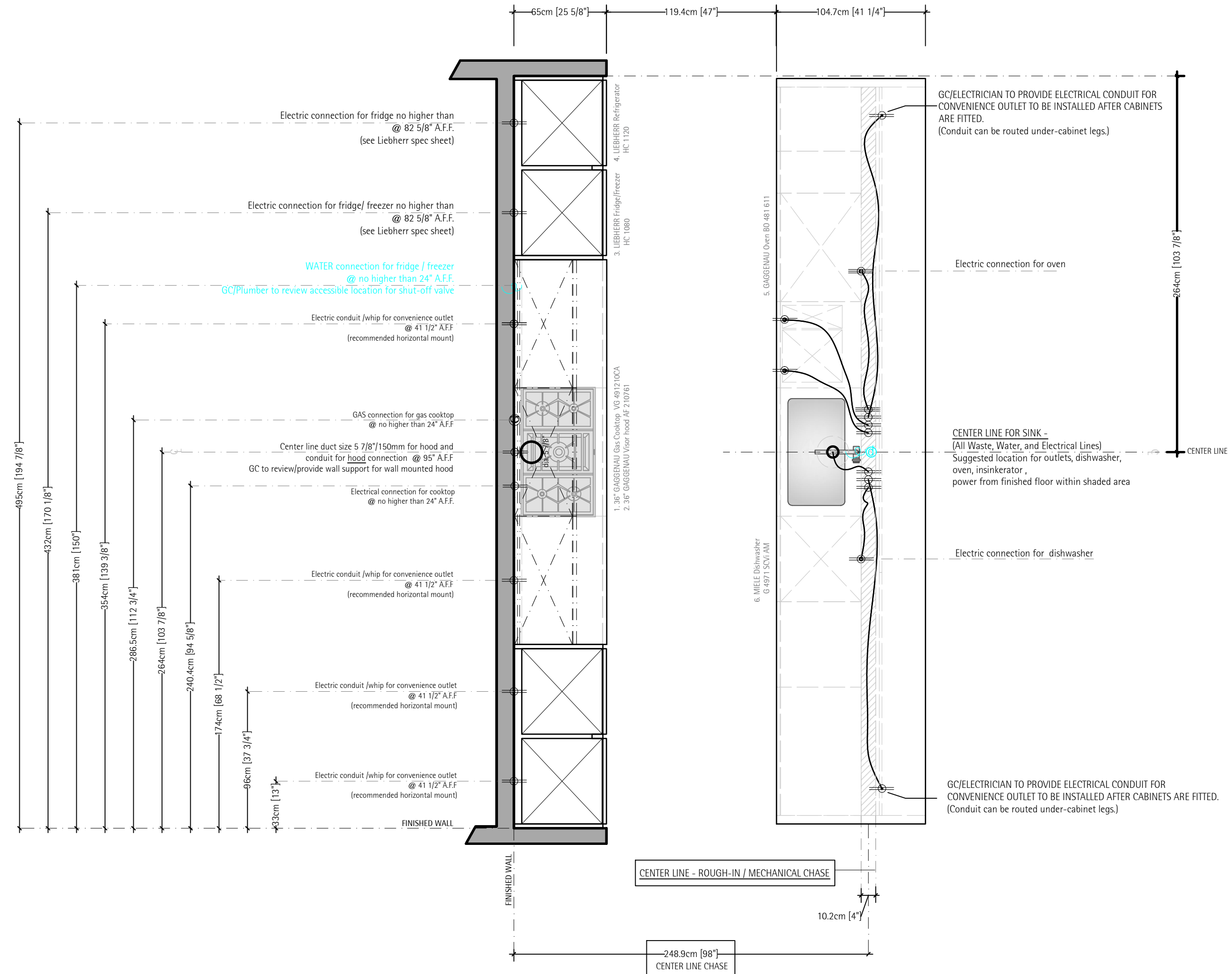

SUGGESTED MECHANICAL ONLY

wall panel and wall units, blocking requirements:

Note to contractor:

Wall panel/ shelving requirements:

G.C. to provide 5/8" AC grade plywood sheathing @ 37" A.F.F. to 107 7/8" for support for wall panels and upper cabinets. Optional for plywood to entire wall

No sheetrock on top of plywood.
All visible plywood will be covered by panels/cabinets.

SEE IMAGES

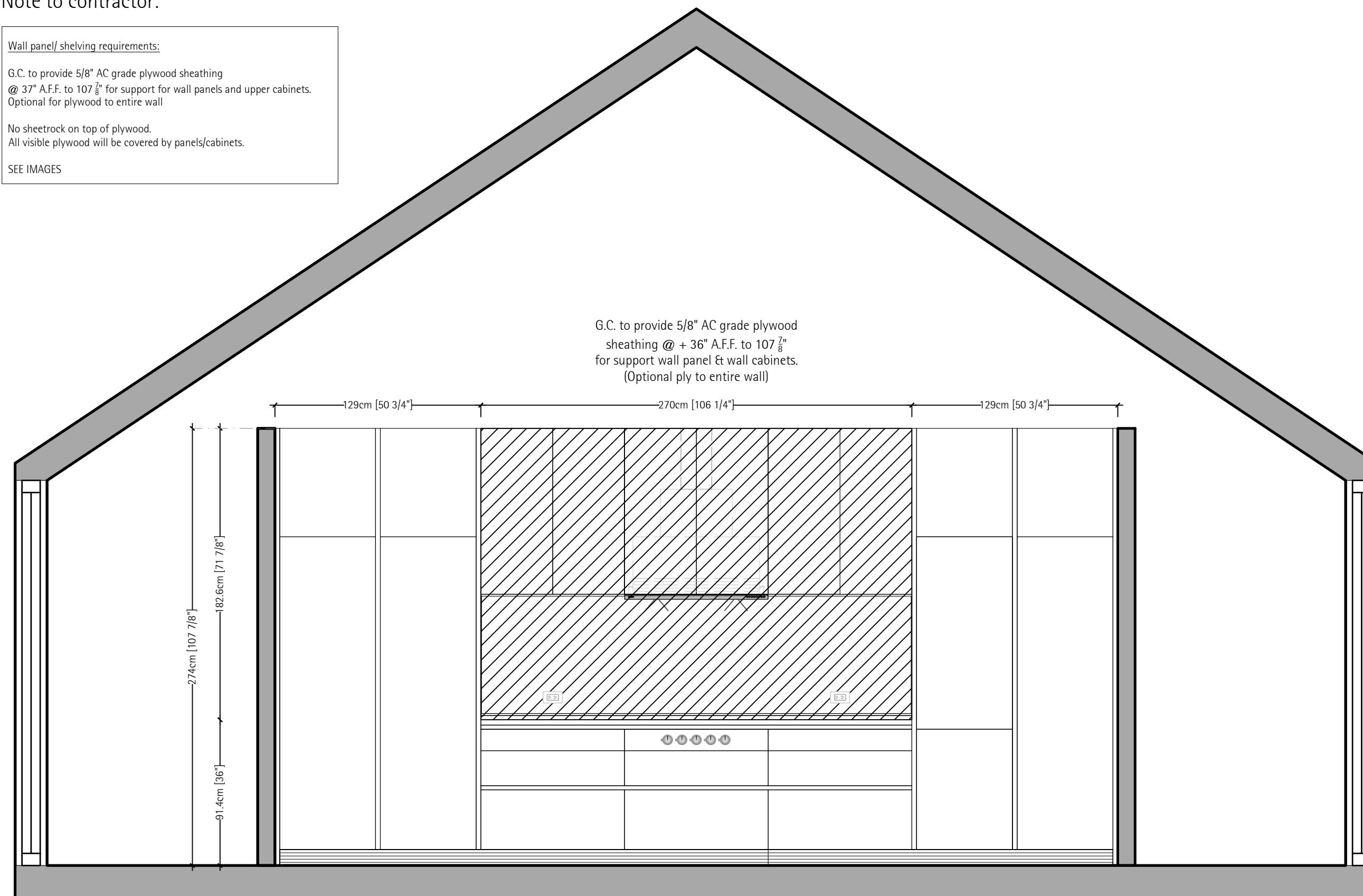

Elevation A hatched area requires plywood sheathing for hanging bracket system.

Note to Contractor:

Blocking Diagram - cabinets 65cm depth

Important: plywood sheathing is required for the wall A. Blocking to be flush with plywall.

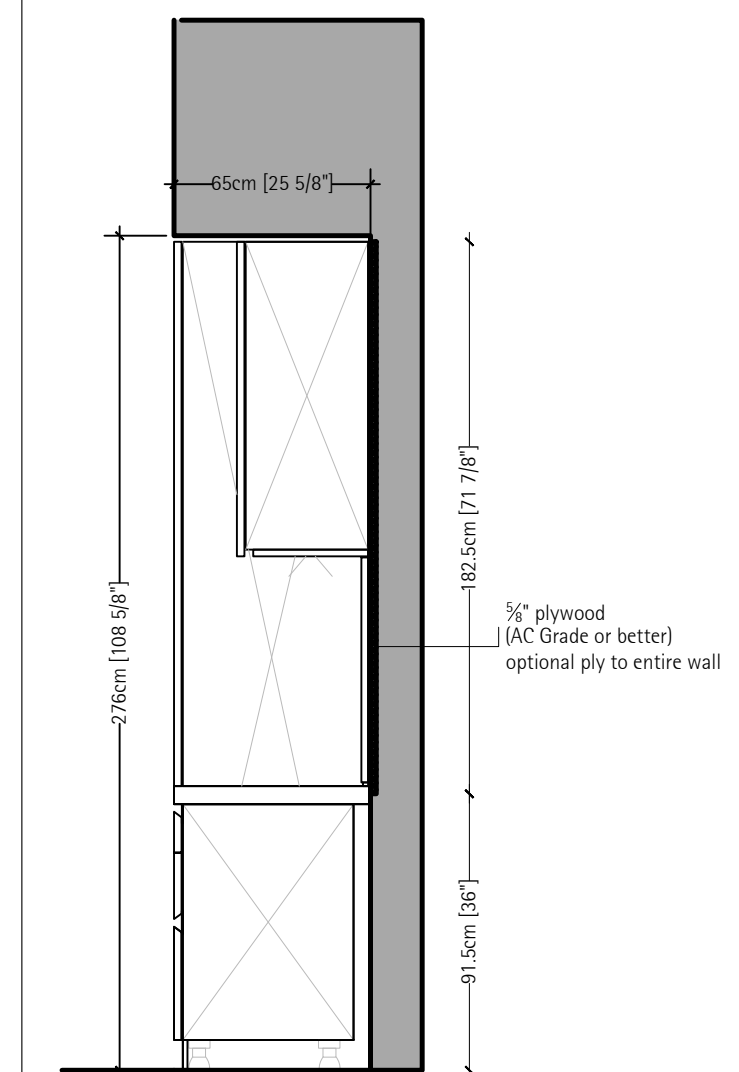

Image Examples:

Plywood sheathing w/ bulthaup steel brackets, horizontal + vertical

Tape/Mud/Feather at all sheetrock & plywood joints
No sheetrock on top of plywood.
All visible plywood will be covered by panels/cabinets.

bulthaup hanging rails on 5/8" plywood sheathing



Mud + feather Plywood at edges
5/8" or 3/4" AC grade plywood for bulthaup wall panel / wall unit bracket system support

ELECTRICAL OUTLETS

Conduit for convenience outlets at bulthaup wall panels:
Image Example: bulthaup wall panels fitted for electrical outlets
electrical conduit left loose - fitted w/ box after wall panel is installed

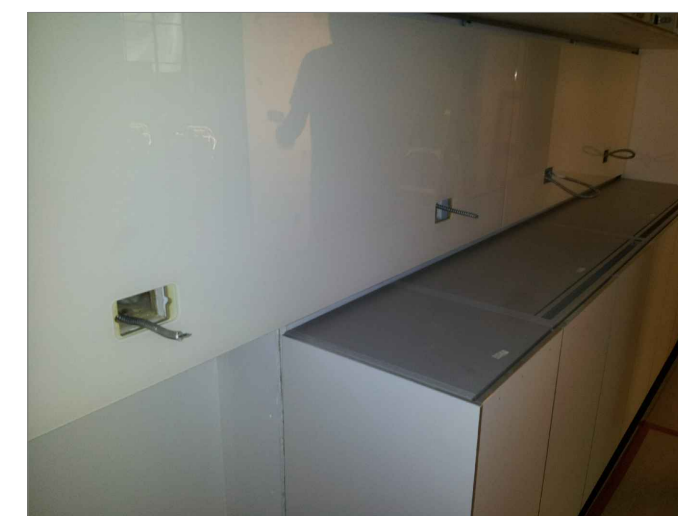

SUGGESTED MECHANICAL ONLY

NOTE: ALL CONNECTIONS MUST BE DONE IN ACCORDANCE TO LOCAL CODES

All appliances installed according to specifications

Note to plumber:

Sink plumbing requirements:
 Hold plumbing tight to the rear wall.
 Turn p-trap parallel to the rear wall to not interfere with bulthaup waste bins or pull out box
 SEE IMAGES BELOW

SECTION 2: Rear Wall Sink Cabinet, front section

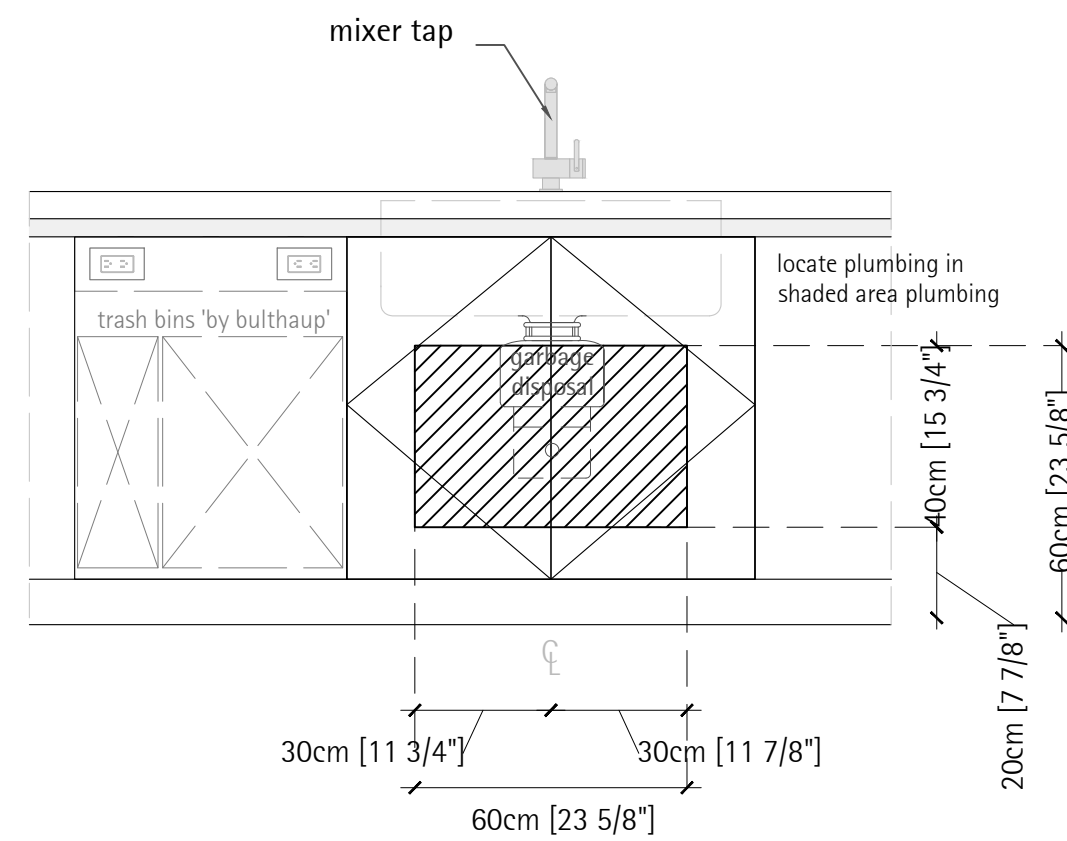

EXAMPLE - STRAINER AND PTRAP



EXAMPLE - ELECTRICAL CONDUIT AT ISLAND



EXAMPLE - ISLAND PLUMBING LOOP



SUGGESTED MECHANICAL ONLY

NOTE: ALL CONNECTIONS MUST BE DONE IN ACCORDANCE TO LOCAL CODES

All appliances installed according to specifications

Note to contractor/architect:

Niche Planning:

No filler detail at cabinet and wall junctions or cabinet and soffit junctions.

.. Tight reveal, tight tolerance at finished wall and cabinet, finished soffit and cabinet.

bulthaup cabinets require $\frac{3}{4}$ " height to hang to bracket system behind

Drywall specialist to finish wing walls and soffit after cabinet installation -adjust tolerance with corner bead for tight niche detailing.

Critical wing walls are square/level/plum

Refer images Et PDF provided

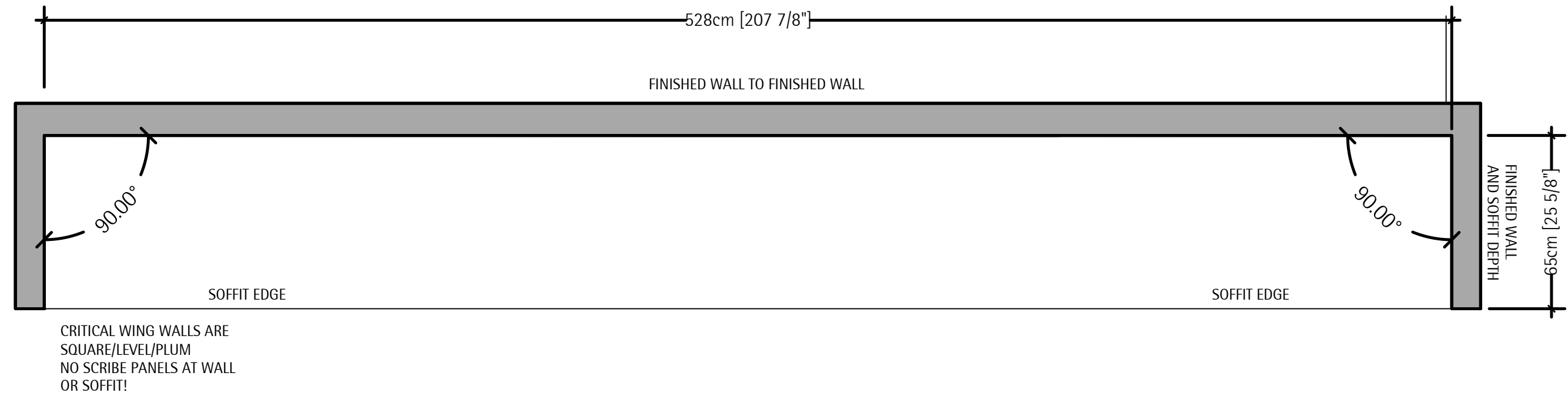

Floor Plan - Wall A (Soffit Placement)

EXAMPLE - Tight niche detailing



EXAMPLE - Tight niche detailing

